

# Stanz- und Nibbelwerkzeuge System

## Behrens

Preisliste 10/97-B

System

**Behrens**

**PASS STÄNZTECHNIK AG**

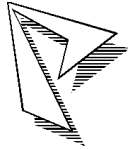

Am Steinkreuz 2  
95473 Creußen / Ofr.  
Postfach 1260  
Telefon: 09270/985-0  
Telefax: 09270/985-99



**Inhaltsverzeichnis:**

Standardwerkzeuge .....	4-7
Zubehör .....	8
Sonderformwerkzeuge SF 1 - SF 17 .....	9-14
Trennmesser .....	15
Stempel mit Scherschräge .....	16
Aufpreise für Beschichtungen .....	17
Sonderlagen bei Stempeln .....	18
Matrizen für Maschinen 1025 und CB25 .....	19
Standardeinstellung .....	20
Einbaulage .....	21
Persönliche Notizen .....	22-25

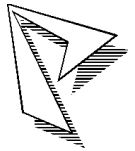

System  
**Behrens**

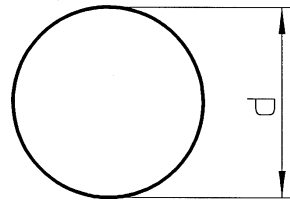

Am Steinkreuz 2  
95473 Creußen / Ofr.  
Postfach 1260  
Telefon: 09270/985-0  
Telefax: 09270/985-99

Stempel	Station	Bereich "d"	Art.-Nr.	Preis	d	L
	B	-25,00	301B11		16	71
	C	-38,00	301C11		24	79
	D	-50,00	301D11		32	91
	E	-63,00	301E11		45	91
	F	-80,00	301F11		45	91
	G	-90,00	301G11		50	91
	H	-100,00	301H11		85	91

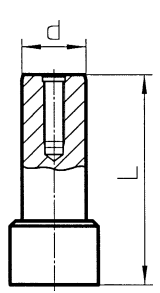

Matrize	Station	Bereich "d"	Art.-Nr.	Preis	D	H
	B	-27,00	306B11		40	15
	C	-40,00	306C11		57	15
	D	-52,00	306D11		70	19
	E	-65,00	306E11		90	19
	F	-82,00	306F11		108	19
	G	-92,00	306G11		120	19
	H	-102,00	306H11		130	19

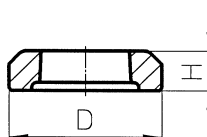

Abstreifer Form 2	Station	Bereich "d"	Art.-Nr.	Preis	D	H
	B	-28,00	311B11		60,33	14
	C	-41,00	311C11		68,26	14,00
	D	-53,00	311D11		73,03	14
	E	-66,00	311E11		109,54	14
	F	-83,00	311F11		109,54	14
	G	-93,00	311G11		115,09	14

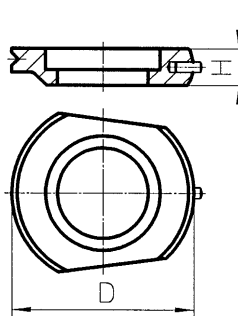

Abstreifer Form 3	Station	Bereich "d"	Art.-Nr.	Preis	B	H
	B	-28,00	310B11		39,9	14
	C	-41,00	310C11		51,9	14
	D	-53,00	310D11		59,9	14
	E	-66,00	310E11		111,9	14
	F	-83,00	310F11		111,9	14
	G	-93,00	310G11		116,9	14
	H	-103,00	310H11		125,9	14

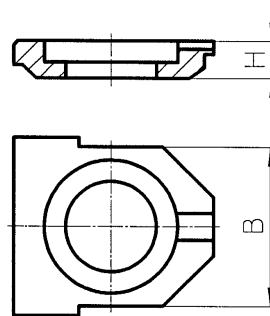

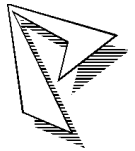

System  
**Behrens**

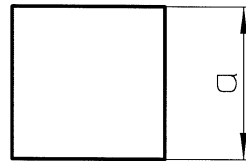

Am Steinkreuz 2  
95473 Creußen / Ofr.  
Postfach 1260  
Telefon: 09270/985-0  
Telefax: 09270/985-99

Stempel	Station	Bereich "a"	Art.-Nr.	Preis	d	L
	B	-17,70	301B12		16	71
	C	-26,90	301C12		24	79
	D	-35,40	301D12		32	91
	E	-44,60	301E12		45	91
	F	-56,60	301F12		45	91
	G	-63,60	301G12		50	91
	H	-70,80	301H12		85	91

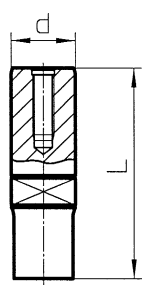

Matrize	Station	Bereich "a"	Art.-Nr.	Preis	D	H
	B	-19,70	306B12		40	15
	C	-28,90	306C12		57	15
	D	-37,40	306D12		70	19
	E	-46,60	306E12		90	19
	F	-58,60	306F12		108	19
	G	65,60	306G12		120	19
	H	-72,80	306H12		130	19

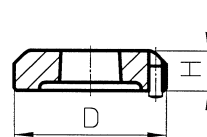

Abstreifer Form 2	Station	Bereich "a"	Art.-Nr.	Preis	D	H
	B	-20,70	311B12		60,33	14
	C	-29,90	311C12		68,26	14
	D	-38,40	311D12		73,03	14
	E	-47,60	311E12		109,54	14
	F	-59,60	311F12		109,54	14
	G	-66,60	311G12		115,09	14

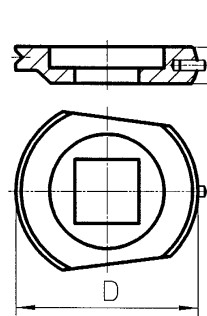

Abstreifer Form 3	Station	Bereich "a"	Art.-Nr.	Preis	B	H
	B	-20,70	310B12		39,9	14
	C	-26,90	310C12		51,9	14
	D	-38,40	310D12		59,9	14
	E	-47,60	310E12		111,9	14
	F	-59,60	310F12		111,9	14
	G	-66,60	310G12		116,9	14
	H	-73,80	310H12		125,9	14

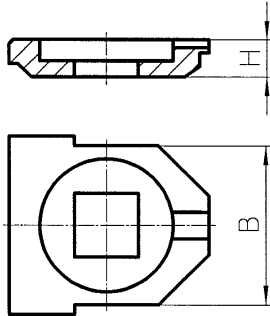

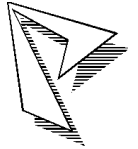

System  
**Behrens**

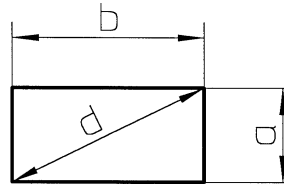

Am Steinkreuz 2  
95473 Creußen / Ofr.  
Postfach 1260  
Telefon: 09270/985-0  
Telefax: 09270/985-99

Stempel	Station	Bereich "d"	Art.-Nr.	Preis	d	L
	B	-25,00	301B13		16	71
	C	-38,00	301C13		24	79
	D	-50,00	301D13		32	91
	E	-63,00	301E13		45	91
	F	-80,00	301F13		45	91
	G	-90,00	301G13		50	91
	H	-100,00	301H13		85	91

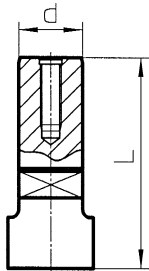

Matrize	Station	Bereich "d"	Art.-Nr.	Preis	D	H
	B	-27,00	306B13		40	15
	C	-40,00	306C13		57	15
	D	-52,00	306D13		70	19
	E	-65,00	306E13		90	19
	F	-82,00	306F13		108	19
	G	-92,00	306G13		120	19
	H	-102,00	306H13		130	19

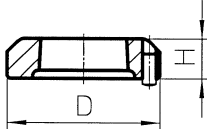

Abstreifer Form 2	Station	Bereich "d"	Art.-Nr.	Preis	D	H
	B	-28,00	311B13		60,33	14
	C	-41,00	311C13		68,26	14
	D	-53,00	311D13		73,03	14
	E	-66,00	311E13		109,54	14
	F	-83,00	311F13		109,54	14
	G	-93,00	311103		115,09	14

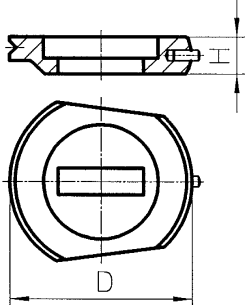

Abstreifer Form 3	Station	Bereich "d"	Art.-Nr.	Preis	B	H
	B	-28,00	310B13		39,9	14
	C	-41,00	310C13		51,9	14
	D	-53,00	310D13		59,9	14
	E	-66,00	310E13		111,9	14
	F	-83,00	310F13		111,9	14
	G	-93,00	310G13		116,9	14
	H	-103,00	310H13		125,9	14



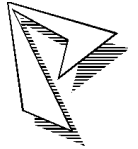

System  
**Behrens**

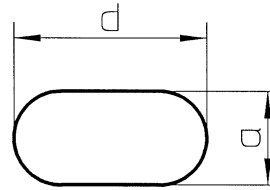

Am Steinkreuz 2  
95473 Creußen / Ofr.  
Postfach 1260  
Telefon: 09270/985-0  
Telefax: 09270/985-99

Stempel	Station	Bereich "d"	Art.-Nr.	Preis	d	L
	B	-25,00	301B14		16	71
	C	-38,00	301C14		24	79
	D	-50,00	301D14		32	91
	E	-63,00	301E14		45	91
	F	-80,00	301F14		45	91
	G	-90,00	301G14		50	91
	H	-100,00	301H14		85	91

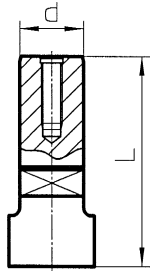

Matrize	Station	Bereich "d"	Art.-Nr.	Preis	D	H
	B	-27,00	306B14		40	15
	C	-40,00	306C14		57	15
	D	-52,00	306D14		70	19
	E	-65,00	306E14		90	19
	F	-82,00	306F14		108	19
	G	-92,00	306G14		120	19
	H	-102,00	306H14		130	19

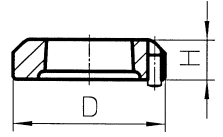

Abstreifer Form 2	Station	Bereich "d"	Art.-Nr.	Preis	D	H
	B	-28,00	311B14		60,33	14
	C	-41,00	311C14		68,26	14
	D	-53,00	311D14		73,03	14
	E	-66,00	311E14		109,54	14
	F	-83,00	311F14		109,54	14
	G	-93,00	311G14		115,09	14

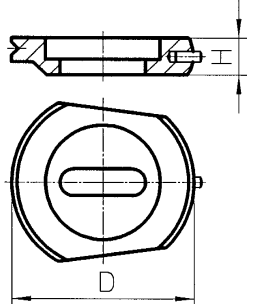

Abstreifer Form 3	Station	Bereich "d"	Art.-Nr.	Preis	B	H
	B	-28,00	310B14		39,9	14
	C	-41,00	310C14		51,9	14
	D	-53,00	310D14		59,9	14
	E	-66,00	310E14		111,9	14
	F	-83,00	310F14		111,9	14
	G	-93,00	310G14		116,9	14
	H	-103,00	310H14		125,9	14

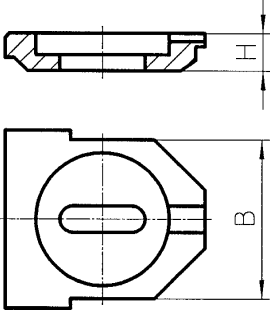

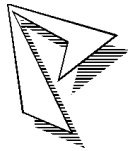

**Stempelfutter für Rundnadeln bis 5,00 mm**

Station	Bereich "d" in mm	Art.-Nr.	Preis	D	d
B	-5,00	3B0401		16	5

**Rund-Stempelnadel bis dm 5,00 mm**

Station	Bereich "d" in mm	Art.-Nr.	Preis	D	L
B	- 5,00	3B0404		5	37,00

**RUND-Nibbelstempel**

Station	Bereich	Art.-Nr.	Preis	D	d
B	10,00	3B0502		16	12,5
B	12,00	3B1502		16	12,5

Die Nibbelstempel werden in HSS/oxidiert ausgeführt.

Sonderausführungen (z.B. TIN-Beschichtung oder Nitrierung) auf Anfrage

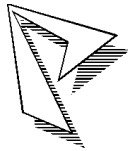

		Stempel		Matrize		Abstreifer Form 2		Abstreifer Form 3		<p>SF1</p>
Stat.	Bereich in mm	Art.-Nr.	Preis	Art.-Nr.	Preis	Art.-Nr.	Preis	Art.-Nr.	Preis	
B	-25,00	315B01		316B01		318B01		317B01		
C	-38,00	315C01		316C01		318C01		317C01		
D	-50,00	315D01		316D01		318D01		317D01		
E	-63,00	315E01		316E01		318E01		317E01		
F	-80,00	315F01		316F01		318F01		317F01		
G	-90,00	315G01		316G01		318G01		317G01		
H	-100,00	315H01		316H01		---	---	317H01		

		Stempel		Matrize		Abstreifer Form 2		Abstreifer Form 3		<p>SF2</p>
Stat.	Bereich in mm	Art.-Nr.	Preis	Art.-Nr.	Preis	Art.-Nr.	Preis	Art.-Nr.	Preis	
B	-25,00	315B02		316B02		318B02		317B02		
C	-38,00	315C02		316C02		318C02		317C02		
D	-50,00	315D02		316D02		318D02		317D02		
E	-63,00	315E02		316E02		318E02		317E02		
F	-80,00	315F02		316F02		318F02		317F02		
G	-90,00	315G02		316G02		318G02		317G02		
H	-100,00	315H02		316H02		---	---	317H02		

		Stempel		Matrize		Abstreifer Form 2		Abstreifer Form 3		<p>SF3</p>
Stat.	Bereich in mm	Art.-Nr.	Preis	Art.-Nr.	Preis	Art.-Nr.	Preis	Art.-Nr.	Preis	
B	-25,00	315B03		316B03		318B03		317B03		
C	-38,00	315C03		316C03		318C03		317C03		
D	-50,00	315D03		316D03		318C03		317D03		
E	-63,00	315E03		316E03		318E03		317E03		
F	-80,00	315F03		316F03		318F03		317F03		
G	-90,00	315G03		316G03		318G03		317G03		
H	-100,00	315H03		316H03		---	---	317H03		

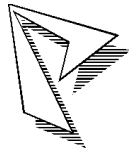

		Stempel		Matrize		Abstreifer Form 2		Abstreifer Form 3		<p>SF4</p>
Stat.	Bereich in mm	Art.-Nr.	Preis	Art.-Nr.	Preis	Art.-Nr.	Preis	Art.-Nr.	Preis	
B	-25,00	315B04		316B04		318B04		317B04		
C	-38,00	315C04		316C04		318C04		317C04		
D	-50,00	315D04		316D04		318D04		317D04		
E	-63,00	315E04		316E04		318E04		317E04		
F	-80,00	315F04		316F04		318F04		317F04		
G	-90,00	315G04		316G04		318G04		317G04		
H	-100,00	315H04		316H04		---	---	317H04		

		Stempel		Matrize		Abstreifer Form 2		Abstreifer Form 3		<p>SF5</p>
Stat.	Bereich in mm	Art.-Nr.	Preis	Art.-Nr.	Preis	Art.-Nr.	Preis	Art.-Nr.	Preis	
B	-25,00	315B05		316B05		318B05		317B05		
C	-38,00	315C05		316C05		318C05		317C05		
D	-50,00	315D05		316D05		318D05		317D05		
E	-63,00	315E05		316E05		318E05		317E05		
F	-80,00	315F05		316F05		318F05		317F05		
G	-90,00	315G05		316G05		318G05		317G05		
H	-100,00	315H05		316H05		---	---	317H05		

		Stempel		Matrize		Abstreifer Form 2		Abstreifer Form 3		<p>SF6</p>
Stat.	Bereich in mm	Art.-Nr.	Preis	Art.-Nr.	Preis	Art.-Nr.	Preis	Art.-Nr.	Preis	
B	-25,00	315B06		316B06		318B06		317B06		
C	-38,00	315C06		316C06		318C06		317C06		
D	-50,00	315D06		316D06		318D06		317D06		
E	-63,00	315E06		316E06		318E06		317E06		
F	-80,00	315F06		316F06		318F06		317F06		
G	-90,00	315G06		316G06		318G06		317G06		
H	-100,00	315H06		316H06		---	---	317H06		

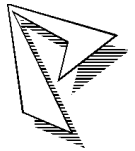

System  
**Behrens**

Am Steinkreuz 2  
95473 Creußen / Ofr.  
Postfach 1260  
Telefon: 09270/985-0  
Telefax: 09270/985-99

		Stempel		Matrize		Abstreifer Form 2		Abstreifer Form 3		
Stat.	Bereich in mm	Art.-Nr.	Preis	Art.-Nr.	Preis	Art.-Nr.	Preis	Art.-Nr.	Preis	
B	-25,00	315B07		316B07		318B07		317B07		
C	-38,00	315C07		316C07		318C07		317C07		
D	-50,00	315D07		316D07		318D07		317D07		
E	-63,00	315E07		316E07		318E07		317E07		
F	-80,00	315F07		316F07		318F07		317F07		
G	-90,00	315G07		316G07		318G07		317G07		
H	-100,00	315H07		316H07		---	---	317H07		

		Stempel		Matrize		Abstreifer Form 2		Abstreifer Form 3		
Stat.	Bereich in mm	Art.-Nr.	Preis	Art.-Nr.	Preis	Art.-Nr.	Preis	Art.-Nr.	Preis	
B	-25,00	315B08		316B08		318B08		317B08		
C	-38,00	315C08		316C08		318C08		317C08		
D	-50,00	315D08		316D08		318D08		317D08		
E	-63,00	315E08		316E08		318E08		317E08		
F	-80,00	315F08		316F08		318F08		317F08		
G	-90,00	315G08		316G08		318G08		317G08		
H	-100,00	315H08		316H08		---	---	317H08		

		Stempel		Matrize		Abstreifer Form 2		Abstreifer Form 3		
Stat.	Bereich in mm	Art.-Nr.	Preis	Art.-Nr.	Preis	Art.-Nr.	Preis	Art.-Nr.	Preis	
B	-25,00	315B09		316B09		318B09		317B09		
C	-38,00	315C09		316C09		318C09		317C09		
D	-50,00	315D09		316D09		318D09		317D09		
E	-63,00	315E09		316E09		318E09		317E09		
F	-80,00	315F09		316F09		318F09		317F09		
G	-90,00	315G09		316G09		318G09		317G09		
H	-100,00	315H09		316H09		---	---	317H09		

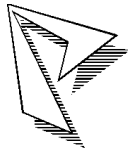

Stat.	Bereich in mm	Stempel		Matrize		Abstreifer Form 2		Abstreifer Form 3		
		Art.-Nr.	Preis	Art.-Nr.	Preis	Art.-Nr.	Preis	Art.-Nr.	Preis	
B	-25,00	315B10		316B10		318B10		317B10		<p><b>SF10</b></p>
C	-38,00	315C10		316C10		318C10		317C10		
D	-50,00	315D10		316D10		318D10		317D10		
E	-63,00	315E10		316E10		318E10		317E10		
F	-80,00	315F10		316F10		318F10		317F10		
G	-90,00	315G10		316G10		318G10		317G10		
H	-100,00	315H10		316H10		---	---	317H10		

Stat.	Bereich in mm	Stempel		Matrize		Abstreifer Form 2		Abstreifer Form 3		
		Art.-Nr.	Preis	Art.-Nr.	Preis	Art.-Nr.	Preis	Art.-Nr.	Preis	
B	-25,00	315B11		316B11		318B11		317B11		<p><b>SF11</b></p>
C	-38,00	315C11		316C11		318C11		317C11		
D	-50,00	315D11		316D11		318D11		317D11		
E	-63,00	315E11		316E11		318E11		317E11		
F	-80,00	315F11		316F11		318F11		317F11		
G	-90,00	315G11		316G11		318G11		317G11		
H	-100,00	315H11		316H11		---	---	317H11		

Stat.	Bereich in mm	Stempel		Matrize		Abstreifer Form 2		Abstreifer Form 3		
		Art.-Nr.	Preis	Art.-Nr.	Preis	Art.-Nr.	Preis	Art.-Nr.	Preis	
B	-25,00	315B12		316B12		318B12		317B12		<p><b>SF12</b></p>
C	-38,00	315C12		316C12		318C12		317C12		
D	-50,00	315D12		316D12		318D12		317D12		
E	-63,00	315E12		316E12		318E12		317E12		
F	-80,00	315F12		316F12		318F12		317F12		
G	-90,00	315G12		316G12		318G12		317G12		
H	-100,00	315H12		316H12		---	---	317H12		

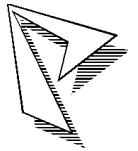

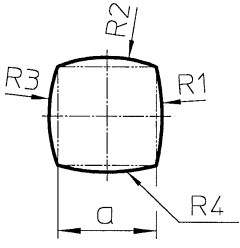
Stat.	Bereich in mm	Stempel		Matrize		Abstreifer Form 2		Abstreifer Form 3		
		Art.-Nr.	Preis	Art.-Nr.	Preis	Art.-Nr.	Preis	Art.-Nr.	Preis	
B	-25,00	315B13		316B13		318B13		317B13		SF13
C	-38,00	315C13		316C13		318C13		317C13		
D	-50,00	315D13		316D13		318D13		317D13		
E	-63,00	315E13		316E13		318E13		317E13		
F	-80,00	315F13		316F13		318F13		317F13		
G	-90,00	315G13		316G13		318G13		317G13		
H	-100,00	315H13		316H13		---	---	317H13		

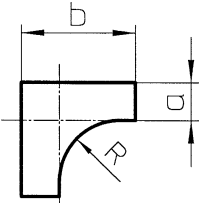
Stat.	Bereich in mm	Stempel		Matrize		Abstreifer Form 2		Abstreifer Form 3		
		Art.-Nr.	Preis	Art.-Nr.	Preis	Art.-Nr.	Preis	Art.-Nr.	Preis	
B	-25,00	315B14		316B14		318B14		317B14		SF14
C	-38,00	315C14		316C14		318C14		317C14		
D	-50,00	315D14		316D14		318D14		317D14		
E	-63,00	315E14		316E14		318E14		317E14		
F	-80,00	315F14		316F14		318F14		317F14		
G	-90,00	315G14		316G14		318G14		317G14		
H	-100,00	315H14		316H14		---	---	317H14		

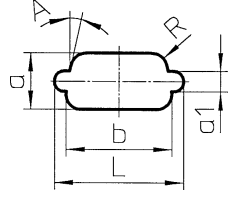
Stat.	Bereich in mm	Stempel		Matrize		Abstreifer Form 2		Abstreifer Form 3		
		Art.-Nr.	Preis	Art.-Nr.	Preis	Art.-Nr.	Preis	Art.-Nr.	Preis	
B	-25,00	315B15		316B15		318B15		317B15		SF15
C	-38,00	315C15		316C15		318C15		317C15		
D	-50,00	315D15		316D15		318D15		317D15		
E	-63,00	315E15		316E15		318E15		317E15		
F	-80,00	315F15		316F15		318F15		317F15		
G	-90,00	315G15		316G15		318G15		317G15		
H	-100,00	315H15		316H15		---	---	317H15		

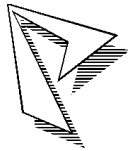

Stat.	Bereich in mm	Stempel		Matrize		Abstreifer Form 2		Abstreifer Form 3		
		Art.-Nr.	Preis	Art.-Nr.	Preis	Art.-Nr.	Preis	Art.-Nr.	Preis	
B	-25,00	315B16		316B16		318B16		317B16		
C	-38,00	315C16		316C16		318C16		317C16		
D	-50,00	315D16		316D16		318D16		317D16		
E	-63,00	315E16		316E16		318E16		317E16		
F	-80,00	315F16		316F16		318F16		317F16		
G	-90,00	315G16		316G16		318G16		317G16		
H	-100,00	315H16		316H16		---	---	317H16		

Stat.	Bereich in mm	Stempel		Matrize		Abstreifer Form 2		Abstreifer Form 3		
		Art.-Nr.	Preis	Art.-Nr.	Preis	Art.-Nr.	Preis	Art.-Nr.	Preis	
B	-25,00	315B17		316B17		318B17		317B17		
C	-38,00	315C17		316C17		318C17		317C17		
D	-50,00	315D17		316D17		318D17		317D17		
E	-63,00	315E17		316E17		318E17		317E17		
F	-80,00	315F17		316F17		318F17		317F17		
G	-90,00	315G17		316G17		318G17		317G17		
H	-100,00	315H17		316H17		---	---	317H17		

Für andere, hier nicht aufgeführte Konturen bitten wir um Ihre Anfrage.

Der Bereich „d“ wird durch den max. Hüllkreis (Zirkelumschlag) in Abhängigkeit vom Werkzeugmittelpunkt ermittelt.  
(siehe nebenstehende Zeichnung)

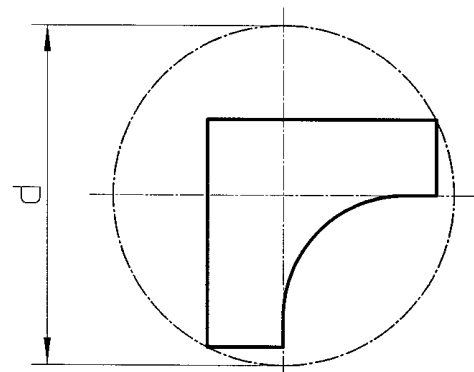

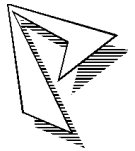

**Trennmesser (seitlich anschraubbar)**

Abmessung	Art.-Nr.	Preis		
Rechteck 6 x 40 / 4 x R = 0	35080005			
Rechteck 6 x 40 / 4 x R = 1	35080010			
Rechteck 10 x 40 / 4 x R = 0	35080015			
Rechteck 10 x 40 / 4 x R = 1	35080020			

**Trennmesser (seitlich anschraubbar)**

Abmessung	Art.-Nr.	Preis		
Rechteck 6 x 60 / 4 x R = 0	35080025			
Rechteck 6 x 60 / 4 x R = 1	35080030			
Rechteck 10 x 60 / 4 x R = 0	35080035			
Rechteck 10 x 60 / 4 x R = 1	35080040			

**Trennmesser (seitlich anschraubbar)**

Abmessung	Art.-Nr.	Preis		
Rechteck 6 x 90 / 4 x R = 0	35080045			
Rechteck 6 x 90 / 4 x R = 1	35080050			
Rechteck 10 x 90 / 4 x R = 0	35080055			
Rechteck 10 x 90 / 4 x R = 1	35080060			

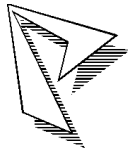

Stempel mit Scherschräge				
Ausführungen	Station	Bereich "d"	Artikelzusatznummer	Aufpreis
	B	-25,00	WT-B	
	C	-38,00	WT-C	
	D	-50,00	WT-D	
	E	-63,00	WT-E	
	F	-80,00	WT-F	
	G	-90,00	WT-G	
	H	-100,00	WT-H	
		B	-25,00	DOWT-B
C		-38,00	DOWT-C	
D		-50,00	DOWT-D	
E		-63,00	DOWT-E	
F		-80,00	DOWT-F	
G		-90,00	DOWT-G	
H		-100,00	DOWT-H	
		B	-25,00	2PT-B
	C	-38,00	2PT-C	
	D	-50,00	2PT-D	
	E	-63,00	2PT-E	
	F	-80,00	2PT-F	
	G	-90,00	2PT-G	
	H	-100,00	2PT-H	
		B	-25,00	4PT-B
C		-38,00	4PT-C	
D		-50,00	4PT-D	
E		-63,00	4PT-E	
F		-80,00	4PT-F	
G		-90,00	4PT-G	
H		-100,00	4PT-H	

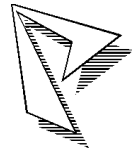

**Aufpreise für TIN (titannitrid)- beschichtete Stempel**

Station	Bereich	Artikelzusatznummer	Aufpreis
B	-25,00	3TIN-B	
C	-38,00	3TIN-C	
D	-50,00	3TIN-D	
E	-63,00	3TIN-E	
F	-80,00	3TIN-F	
G	-90,00	3TIN-G	
H	-100,00	3TIN-H	

**Aufpreise für oxidierte Stempel**

Station	Bereich	Artikelzusatznummer	Aufpreis
B	-25,00	3Oxi-B	
C	-38,00	3Oxi-C	
D	-50,00	3Oxi-D	
E	-63,00	3Oxi-E	
F	-80,00	3Oxi-F	
G	-90,00	3Oxi-G	
H	-100,00	3Oxi-H	

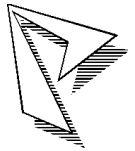

Stempel mit Sonderlage			
Station	Bereich	Artikelzusatznummer	Aufpreis
B	-25,00	3L1-B-?	
C	-38,00	3L1-C-?	
D	-50,00	3L1-D-?	
E	-63,00	3L1-E-?	
F	-80,00	3L1-F-?	
G	-90,00	3L1-G-?	
H	-100,00	3L1-H-?	

Statt "?" ist die gewünschte Verdrehung "A" in Grad (°) bekanntzugeben.

Bei Matrizen und Abstreifern wird kein Aufpreis verrechnet.

Stempel mit 8-kant (Lage = 0 - 45 - 90 - 135°)			
Station	Bereich	Artikelzusatznummer	Aufpreis
B	-25,00	3L2-B	
C	-38,00	3L2-C	
D	-50,00	3L2-D	
E	-63,00	3L2-E	
F	-80,00	3L2-F	
G	-90,00	3L2-G	
H	-100,00	3L2-H	

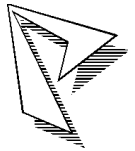

Matrizen mit Höhe = 30 mm (für Maschinen 1025 und CB25 (300kN))

Stationsbereich	"d"	Art.-Nr.	Preis	Fertigungsmaß		
				Durchme	Höhe	
B	-25,00	306BV1		42	30 mm	
C	-38,00	306CV1		57	30 mm	
D	-50,00	306DV1		70	30 mm	
E	-63,00	306EV1		90	30 mm	
F	-80,00	306FV1		108	30 mm	
G	-90,00	306GV1		120	30 mm	
H	-100,00	306HV1		130	30 mm	
B	-25,00	306BV2		42	30 mm	
C	-38,00	306CV2		57	30 mm	
D	-50,00	306DV2		70	30 mm	
E	-63,00	306EV2		90	30 mm	
F	-80,00	306FV2		108	30 mm	
G	-90,00	306GV2		120	30 mm	
H	-100,00	306HV2		130	30 mm	
B	-25,00	306BV3		42	30 mm	
C	-38,00	306CV3		57	30 mm	
D	-50,00	306DV3		70	30 mm	
E	-63,00	306EV3		90	30 mm	
F	-80,00	306FV3		108	30 mm	
G	-90,00	306GV3		120	30 mm	
H	-100,00	306HV3		130	30 mm	
B	-25,00	306BV4		42	30 mm	
C	-38,00	306CV4		57	30 mm	
D	-50,00	306DV4		70	30 mm	
E	-63,00	306EV4		90	30 mm	
F	-80,00	306FV4		108	30 mm	
G	-90,00	306GV4		120	30 mm	
H	-100,00	306HV4		130	30 mm	

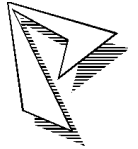

System

**Behrens**

Am Steinkreuz 2  
95473 Creußen / Ofr.  
Postfach 1260  
Telefon: 09270/985-0  
Telefax: 09270/985-99

**Standardeinstellung (Lage = 0°)**

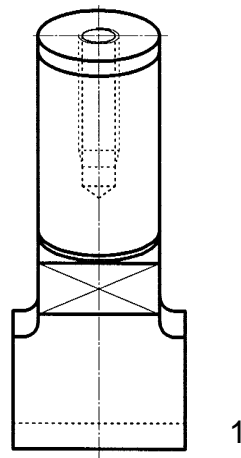

1

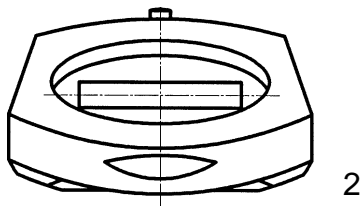

2

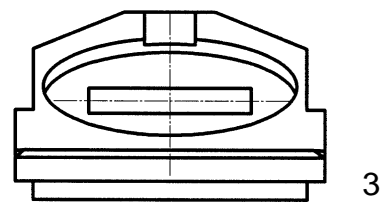

3

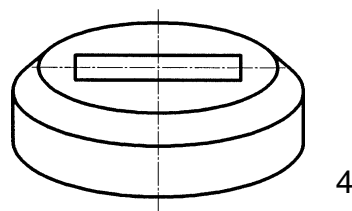

4

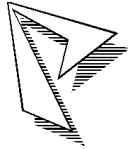

System

**Behrens**

Am Steinkreuz 2  
95473 Creußen / Ofr.  
Postfach 1260  
Telefon: 09270/985-0  
Telefax: 09270/985-99

**Einbaulage**

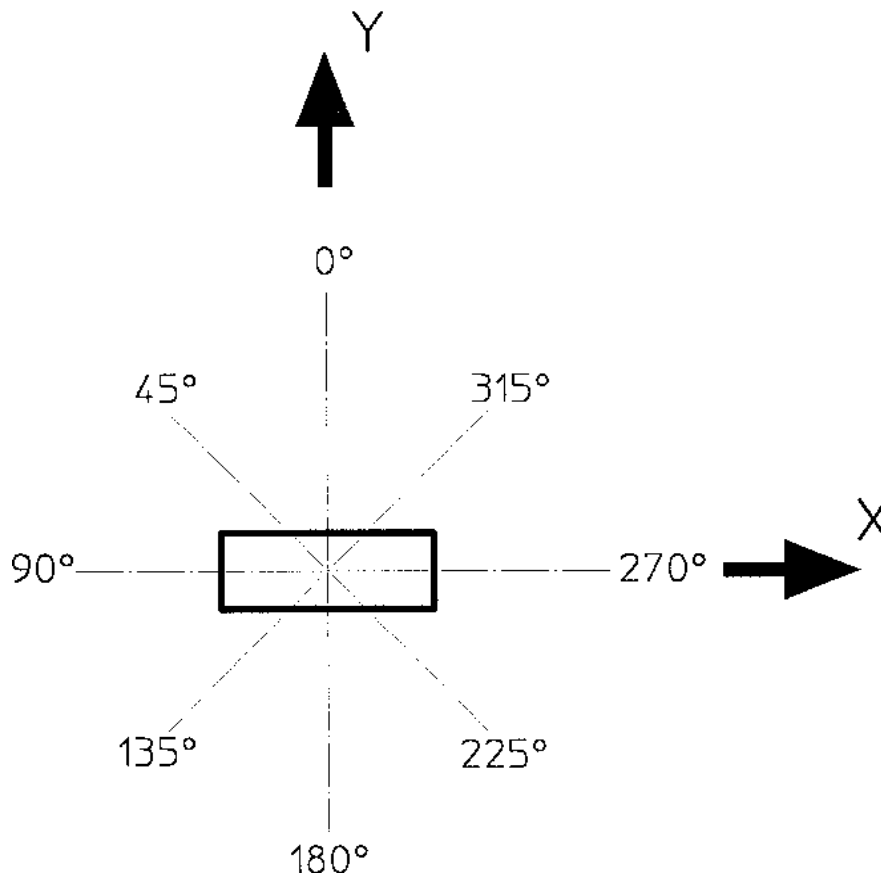









Preisliste 10/97-B

System

**Behrens**

**PASS STÄNZTECHNIK AG**

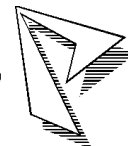

Am Steinkreuz 2  
95473 Creußen / Ofr.  
Postfach 1260  
Telefon: 09270/985-0  
Telefax: 09270/985-99